

Topes

TOPES ESTACIONAMIENTO

TOPE 2 BISEL



PLANTA

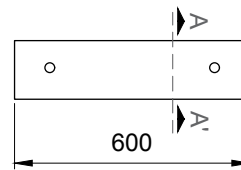

CORTE A-A'

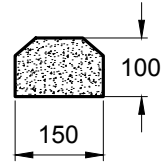

TOPE MEDIACAÑA

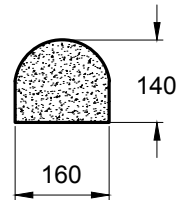
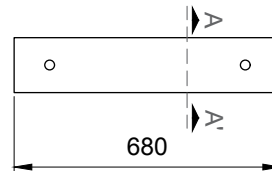

TOPE BAJO

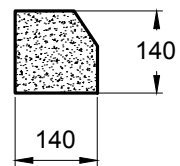

TOPE ALTO

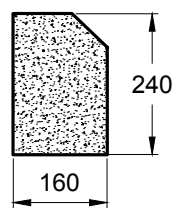
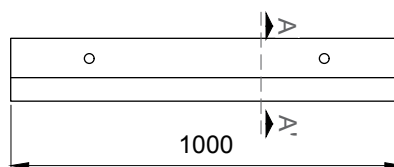

TOPE AUTOELEVADOR

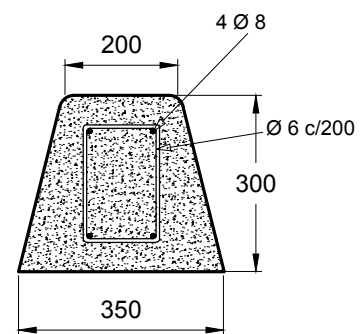
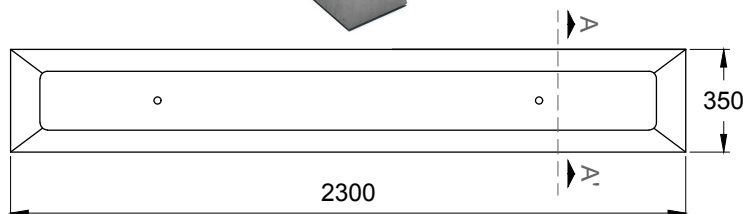

PESO 20-35-45-45-450 kg

TIPO DE OBRA Vial

MEDIDAS Variable

- REV 00
- FV 2019 02 27

Todas las medidas expresadas están en milímetros

Todos los derechos reservados. Prohibida la reproducción total o parcial de esta obra sin la debida autorización por escrito de Premoldeados de Argentina S.A.



premoldeados.com.ar
Tel: +54 11 4312 4010

Reconquista 1034 9° (CP1003)
Buenos Aires — Argentina